

TEST REPORT

NO.: A002R130613039-5R02A1

Date: Jun. 17, 2013

Page 1 of 4

Customer: Astor Chemical Industrial (Jiangsu) Co., Ltd.

Address: NO.3 The Yangtze River Road Jiangsu bonded zone Jiangsu Province

Report on the submitted sample said to be
Sample name: Transparent polystyrene

Model: GPPS EA3300

Item/Lot No.: N06A114Z

Material: /

Buyer: /

Supplier: /

Manufacturer: /

Sample received date: Jun. 13, 2013

Testing period: From Jun. 13, 2013 to Jun. 17, 2013

Testing Requested:

As specified by client, to determine the Lead, Cadmium, Mercury, Hexavalent Chromium, PBB & PBDE content in the submitted sample in accordance with Directive 2011/65/EU (RoHS).

Testing method:

Testing Item	Pretreatment method	Measuring instrument	MQL
Lead (Pb)	IEC 62321: 2008, section 8	ICP-OES	2mg/kg
Cadmium (Cd)	IEC 62321: 2008, section 8	ICP-OES	2 mg/kg
Mercury (Hg)	IEC 62321: 2008, section 7	ICP-OES	2 mg/kg
Chromium (Cr VI)	IEC 62321: 2008, Annex C	UV-VIS	2 mg/kg
PBBs/ PBDEs	IEC 62321: 2008, Annex A	GC-MS	5 mg/kg

Conclusion:

When tested as specified, the submitted sample complied with the requirements of Directive 2011/65/EU (RoHS).

*****FOR FURTHER DETAILS, PLEASE REFER TO THE FOLLOWING PAGE(S)*****

Signed for and on behalf of

Shenzhen AOV Testing Technology Co., Ltd, Kunshan Branch

Project Leader:

 Li Tingting, Maggie
 Chemical Test Director

Reviewed by:

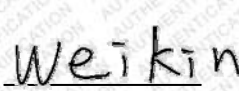
 Wang Wexin, Weikin
 Technical Director

Approved by:

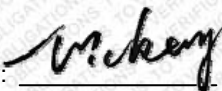
 Yuan Qi, Mickey
 Lab Manager

TEST REPORT

NO.: A002R130613039-5R02A1

Date: Jun. 17, 2013

Page 2 of 4

Test Flow:

1. To Determine Lead, Cadmium Content:

Tested by: *Condy*

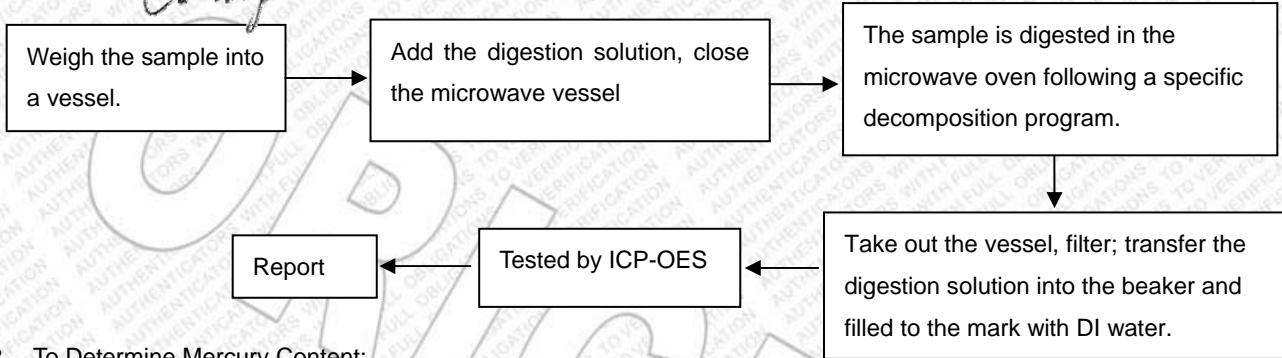

2. To Determine Mercury Content:

Tested by: *Condy*

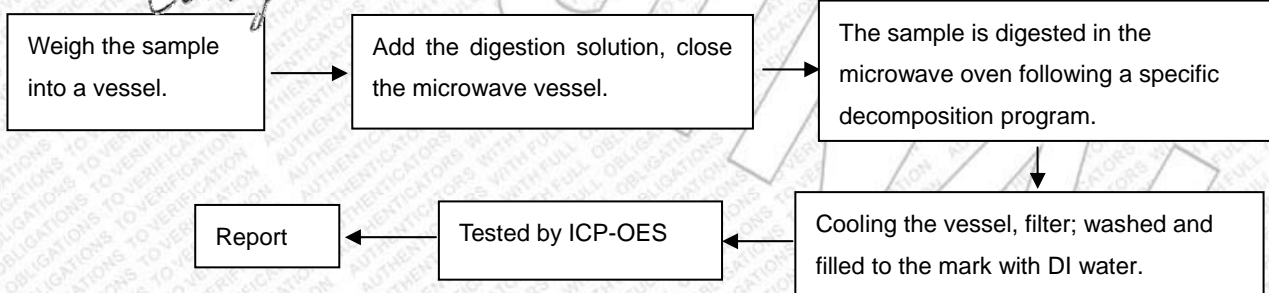

3. To Determine Hexavalent Chromium Content (for Polymer):

Tested by: *Danae*

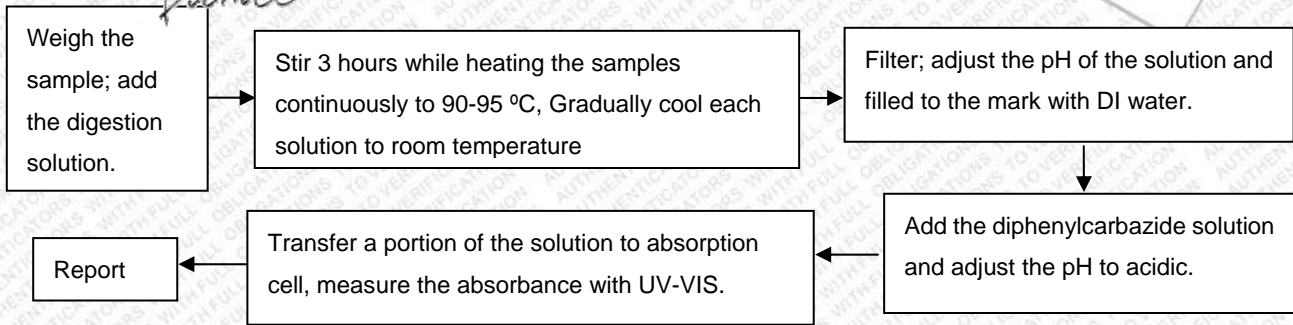

4. To Determine PBBs/PBDEs Content:

Tested by: *Carina*

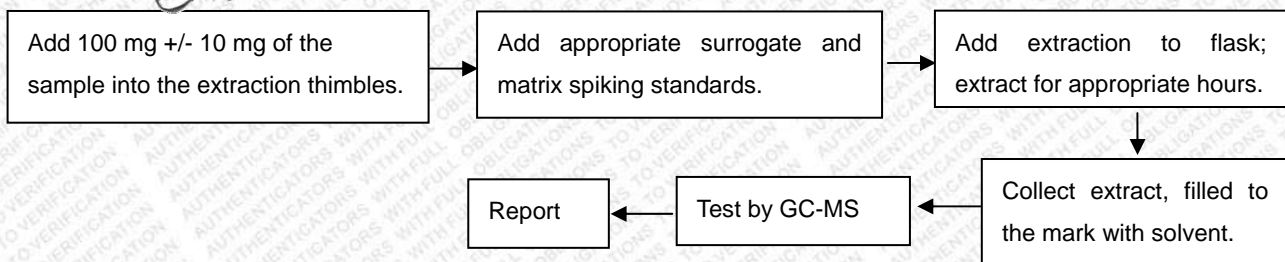

TEST REPORT

NO.: A002R130613039-5R02A1

Date: Jun. 17, 2013

Page 3 of 4

Test Results:

Item	Unit	RoHS Limit	Results
Lead (Pb)	mg/kg	1000	N.D.
Cadmium (Cd)	mg/kg	100	N.D.
Mercury (Hg)	mg/kg	1000	N.D.
Chromium (CrVI)	mg/kg	1000	N.D.

Flame Retardants	Unit	RoHS Limit	Results
PBBs	mg/kg	1000	N.D.
MonoBB	mg/kg	/	N.D.
DiBB	mg/kg	/	N.D.
TriBB	mg/kg	/	N.D.
TetraBB	mg/kg	/	N.D.
PentaBB	mg/kg	/	N.D.
HexaBB	mg/kg	/	N.D.
HeptaBB	mg/kg	/	N.D.
OctaBB	mg/kg	/	N.D.
NonaBB	mg/kg	/	N.D.
DecaBB	mg/kg	/	N.D.
PBDEs	mg/kg	1000	N.D.
MonoBDE	mg/kg	/	N.D.
DiBDE	mg/kg	/	N.D.
TriBDE	mg/kg	/	N.D.
TetraBDE	mg/kg	/	N.D.
PentaBDE	mg/kg	/	N.D.
HexaBDE	mg/kg	/	N.D.
HeptaBDE	mg/kg	/	N.D.
OctaBDE	mg/kg	/	N.D.
NonaBDE	mg/kg	/	N.D.
DecaBDE	mg/kg	/	N.D.

Note:

- Specimens, which requested to determine Lead, Cadmium and Mercury Content, have been dissolved completely.
- N.D.=not detected(<MQL)
- MQL=Method Quantitation Limit
- Photo is included

TEST REPORT

NO.: A002R130613039-5R02A1

Date: Jun. 17, 2013

Page 4 of 4

Photograph of Sample

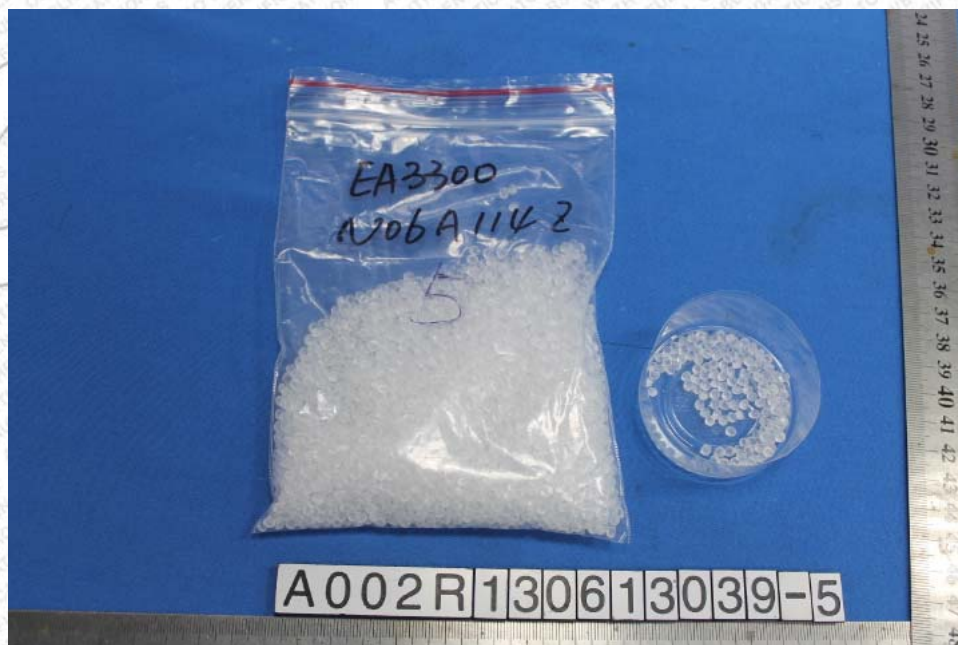

Transparent polystyrene

End of Report